

PRODUCT SPECIFICATIONS

AMP[®]

Project Name _____ Date _____

Type or Model _____ Qty _____

AMP[®] Low Voltage Landscape Lighting Mini SummitPro[™] Path & Area Light

Product Description

Compact yet effective, the Mini SummitPro[™] projects a medium-sized soft-edged beam, ideal for illuminating small to medium-sized areas. Its traditional architectural style adds charm to paths, driveways, flower beds, docks, and patios. With its 13" stem, this fixture provides a subtle beam spread and a less obtrusive appearance, perfect for blending into any landscape. Made of solid cast brass with a pre-aged bronze finish, it offers durability and a timeless look that naturally ages with time. For continuous illumination along a path, space the fixtures about 6 feet apart. For independent pools of light, space about 8.5 feet apart.



Product Dimensions

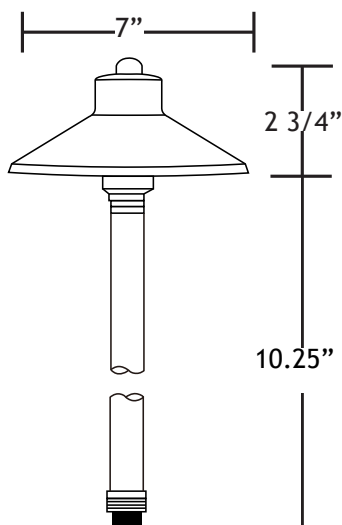

Warranty

Lifetime Warranty

Certifications



Specifications

- ▶ **Construction:** Brass
- ▶ **Finish:** Bronze
- ▶ **Lead Wire:** 18AWG
- ▶ **Mounting:** 10" Hammer[™] stake with cutout for wire exit
- ▶ **Lens:** Clear
- ▶ **Light Source:** LED Bipin (sold separately)
- ▶ **Operating Voltage:** 12VAC
- ▶ **Powered By:** AMP[®] Low Voltage Transformers

Features & Benefits

- ▶ Solid cast brass construction.
- ▶ Pre-aged finish; no powder coating, paint or finish to wear off or peel - just natural patina that does not corrode.
- ▶ Stem is 1-inch thick and includes extra-long (1-inch) strip resistant threading for greater stability.
- ▶ Ceramic white paint under shade for maximum light reflection.
- ▶ Beryllium copper socket - more corrosion resistant than copper.
- ▶ Silicone plug at lead wire exit prevents ground moisture and insects from entering luminaire through stem.